



3400D DE-ICER

OVERVIEW

- Complete package includes:
 - Motor unit
 - 20' mooring lines
 - UL, CSA & NEC approved underwater-rated cable
- Total package Listed by ETL to UL/CSA standards
- Saltwater compatible
- Packaged for convenient shipping

MOTOR UNIT

- 3/4HP, operating voltage of 120Vac, single phase
- 1750 RPM
- Oil cooled
- Continuous duty rated
- 17mm top and bottom bearings
- Thermal overload protection
- Fully utilized heavy-duty carbon ceramic mechanical seal
- Series 300 Austenitic stainless steel can
- Engineering grade thermoplastic top
- Sacrificial anode installed on 316 stainless steel shaft
- Custom engineered UV-resistant thermoplastic 2-blade propeller
- Coated stainless steel cage

CONTROL OPTIONS

- Thermostat Control Panel
 - ANS/UL 514C Thermoplastic Enclosure
 - 120V plug on 6' power cord
 - Thermostat
- Timer & Thermostat Control Panel
 - UL 508 listed
 - UL Type 3r/4x thermoplastic enclosure
 - 120V plug on 6' power cord
 - Thermostat
 - 24-hour mechanical timer

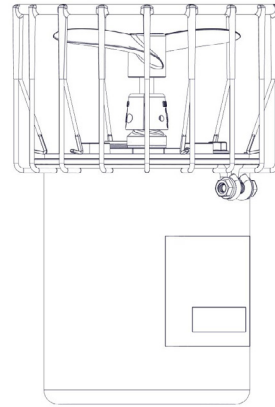

POWER CABLE

- UL, CSA & NEC approved underwater rated cable
- 3 wire (L, N, G)
- Quick Disconnect standard on 12 AWG & larger cords, optional on cords with smaller gauge
- Stainless steel strain relief on 12 AWG & larger cords
- Optional flex sleeving for entire cord length
- Quick Disconnect and stainless steel strain relief included on 12AWG & larger cords

MOUNT OPTIONS

- Universal Dock Mount
 - Complete 300-series stainless steel construction
 - Multiple angling options
 - User supplies 1" pipe, up to 10' long
- Industrial Dock Mount
 - Complete 300-series stainless steel construction
 - Multiple angling options
 - User supplies 1.5" pipe, up to 10' long

3400D DE-ICER

OVERVIEW

HP	Voltage / Phase / Hz	Running Amps	Lock Rotor Amps	Thrust (lbs.)	Min. Depth of Operation (ft.)
3/4	120V / 1 / 60	6.6	18	37	4



NOTE De-icer will operate in less depth but may cause bottom disturbance.

MODEL SPECIFICATIONS

Model	Cord Length (ft.)	Cord Gauge	Number of Boxes
3400D025	25	16/3	1
3400D050	50	16/3	1
3400D100	100	14/3	1
3400D150	150	12/3	2
3400D200	200	12/3	2

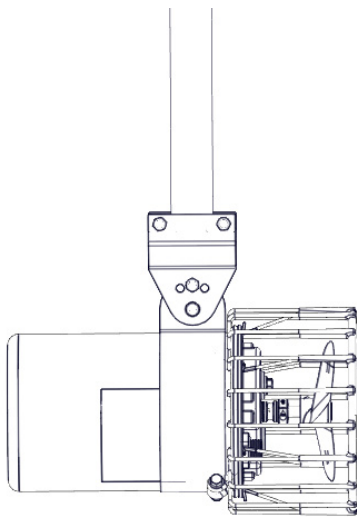

Shown with Industrial Mount

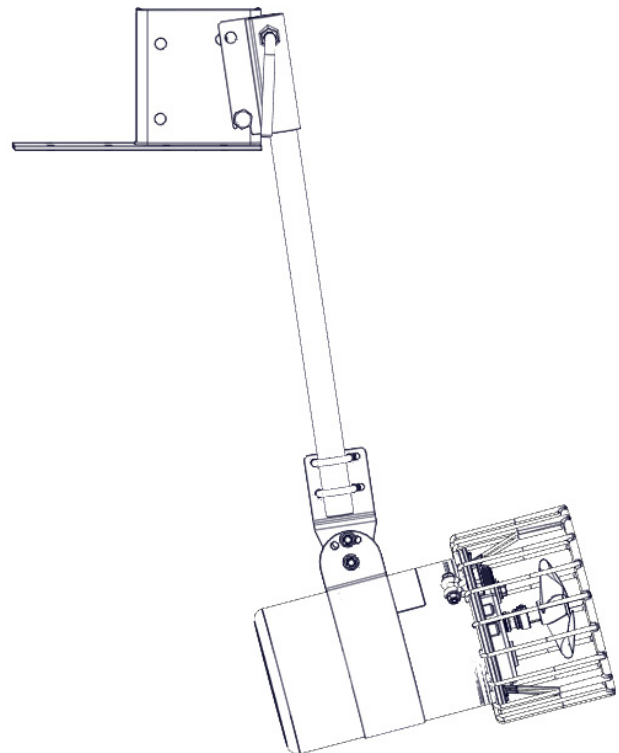

Shown with Universal Mount